

電感式感測器

NRB15-30GM50-E2-C-V1

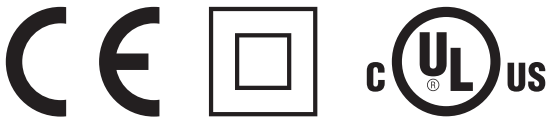

- 減縮因數 = 1
- 耐磁場
- 焊接免疫



Dimensions

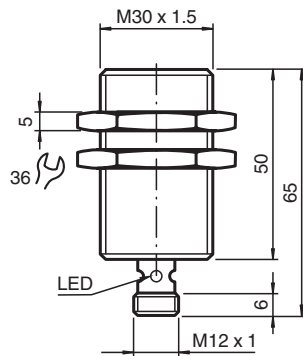

技術數據

一般規格		
切換功能		常開 (NO)
輸出類型		PNP
額定工作距離	s_n	15 mm
安裝		flush
輸出極性		DC
保證工作距離	s_a	0 ... 12.15 mm
縮減因數 r_{Al}		1
縮減因數 r_{Cu}		1
縮減因數 r_{304}		1
縮減因數 r_{Si37}		1
輸出類型		3-wire
標稱額定值		
工作電壓	U_B	10 ... 30 V DC
開關頻率	f	0 ... 750 Hz
磁滯現象	H	typ. 3 %

Release date: 2020-03-24 Date of issue: 2020-03-30 Filename: 261033_eng.pdf

Refer to "General Notes Relating to Pepperl+Fuchs Product Information".

Pepperl+Fuchs Group
www.pepperl-fuchs.com

USA: +1 330 486 0001
fa-info@us.pepperl-fuchs.com

Germany: +49 621 776 1111
fa-info@de.pepperl-fuchs.com

Singapore: +65 6779 9091
fa-info@sg.pepperl-fuchs.com

PF PEPPERL+FUCHS

技術數據

反極性保護		反極性保護
短路保護		脈波
電壓降	U_d	$\leq 2\text{ V}$
額定絕緣電壓	U_{BIS}	60 V
工作電壓	I_L	0 ... 200 mA
斷態電流	I_r	0 ... 0.5 mA typ. 0.1 μA at 25 °C
空載電源電流	I_o	$\leq 14\text{ mA}$
開機時間	t_v	max. 15 ms
恆定磁場	B	200 mT
交變磁場	B	200 mT
開關狀態指示燈		Multihole-LED, yellow
功能安全相關參數		
MTTF _d		1140.2 a
任務時間 (T _M)		20 a
診斷涵蓋率 (DC)		0 %
符合標準和指令		
標準符合性		
標準		EN 60947-5-2:2007 EN 60947-5-2/A1:2012 IEC 60947-5-2:2007 IEC 60947-5-2 AMD 1:2012
批准和證明		
防護等級		II
額定絕緣電壓	U_i	60 V
額定耐衝擊電壓	U_{imp}	800 V
UL 認證		cULus Listed, Type 1 enclosure Class 2 power source
CCC 認證		額定電壓 $\leq 36\text{ V}$ 的產品無需CCC認證 / 標記
環境條件		
環境溫度		-25 ... 70 °C (-13 ... 158 °F)
儲存溫度		-40 ... 85 °C (-40 ... 185 °F)
機械規格		
連接類型		連接頭 M12 x 1 , 4-pin
外殼材料		Brass, PTFE coated
感測面		PPS
防護等級		IP67
重量		113 g
一般信息		
產品內容		隨附2個螺母

Connection

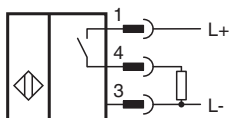



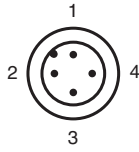

Connection Assignment



Wire colors in accordance with EN 60947-5-2

1	棕	(brown)
2	白	(white)
3	藍	(blue)
4	黑	(black)

Accessories

	BF 30	Mounting flange, 30 mm
	EXG-30	Quick mounting bracket with dead stop
	V1-W-2M-PUR	Female cordset, M12, 4-pin, PUR cable
	V1-G-OR2M-POC	Female cordset single-ended M12 A-coded 4-pin, TPE cable welding-bead resistant orange
	V1-G-2M-PUR	Female cordset, M12, 4-pin, PUR cable

Release date: 2020-03-24 Date of issue: 2020-03-30 Filename: 261033_eng.pdf

Refer to "General Notes Relating to Pepperl+Fuchs Product Information".