



Read/write head

IQH1-FP-V1

- Operating frequency 13.56 MHz
- Conforms to ISO 15693
- Suitable for FRAM transponder
- Dual-LED for function display
- Connection via V1 (M12 x 1) plug connection
- Degree of protection IP67
- For connection to IDENTControl control interface

HF read/write head, ISO 15693, for IDENTControl



Dimensions

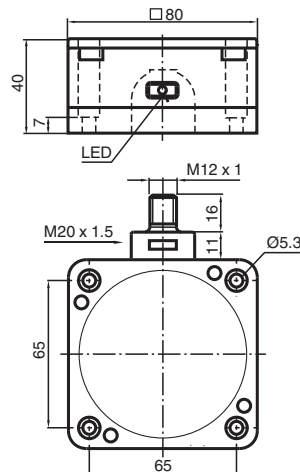

Technical Data

General specifications

Operating frequency	13.56 MHz
Transfer rate	26 kBit/s
Sensing range	
Read distance	0 ... 130 mm
Write distance	0 ... 130 mm
Width	max. 100 mm
UL File Number	E87056

Functional safety related parameters

MTTF _d	220 a
Mission Time (T _M)	10 a
Diagnostic Coverage (DC)	0 %

Indicators/operating means

LED green/yellow	green: power on green flashing: read/write attempt performed yellow: data carrier detected
------------------	--

Electrical specifications

Release date: 2020-04-24 Date of issue: 2020-04-24 Filename: 204623_eng.pdf

Refer to "General Notes Relating to Pepperl+Fuchs Product Information".

Pepperl+Fuchs Group
www.pepperl-fuchs.com

USA: +1 330 486 0001
fa-info@us.pepperl-fuchs.com

Germany: +49 621 776 1111
fa-info@de.pepperl-fuchs.com

Singapore: +65 6779 9091
fa-info@sg.pepperl-fuchs.com

PEPPERL+FUCHS



Technical Data

Power consumption	P_0	$\leq 1.3 \text{ W}$
Supply		from the IDENTControl
Directive conformity		
Radio equipment		
Directive 2014/53/EU		EN 301489-1 EN 301489-3 EN 300330 EN 62368-1 EN 50364
RoHS		
Directive 2011/65/EU (RoHS)		EN 50581
Standard conformity		
Degree of protection		EN 60529
RFID		ISO/IEC 15693-2 ISO/IEC 15693-3 ISO/IEC 18000-3
Approvals and certificates		
FCC approval		This device complies with part 15 of the FCC rules. Operation is subject to the following two conditions: (1) This device may not cause harmful interference, and (2) This device must accept any interference received, including interference that may cause undesired operation. Caution: Changes or modifications not expressly approved by the party responsible for compliance could void the user's authority to operate the equipment.
Ambient conditions		
Ambient temperature		-25 ... 70 °C (-13 ... 158 °F)
Storage temperature		-40 ... 85 °C (-40 ... 185 °F)
Mechanical specifications		
Degree of protection		IP67
Connection		connector M12 x 1
Material		
Housing		PBT
Base		diecast aluminum
Encapsulation compound		CY 221/HY 2966
Installation		
Distance between two heads		Multiplex on: $\geq 100 \text{ mm}$ Multiplex off: $\geq 150 \text{ mm}$
Mass		approx. 380 g

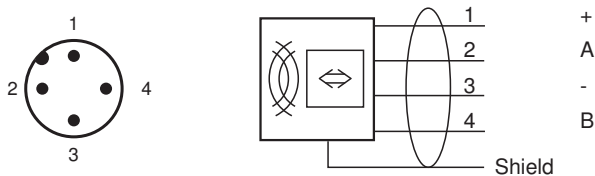













Connection



Accessories

	IC-KP-B6-V15B	Control interface unit IDENTControl with PROFIBUS DP interface
	IC-KP-B17-AIDA1	IDENTControl control interface with Ethernet interface for TCP/IP, PROFINET, EtherNet/IP, and MODBUS TCP protocols

Accessories

	IC-KP2-2HRX-2V1	Control interface unit IDENTControl Compact with serial interface RS-232 and RS-485
	IC-KP2-2HB6-V15B	Control interface unit IDENTControl Compact with interface for PROFIBUS DP
	IC-KP2-2HB17-2V1D	IDENTControl Compact control interface with Ethernet interface for TCP/IP, PROFINET, EtherNet/IP, and MODBUS TCP protocols
	IC-KP2-2HB21-2V1D	Control interface unit IDENTControl Compact with EtherCAT interface
	IQC21-16 50pcs	Data carrier
	IQC21-30 25pcs	Data carrier
	IQC21-50F-T10	Data carrier
	IQC21-58	Data carrier
	IQC22-22-T9 50pcs	Data carrier
	IQC33-20 50pcs	Data carrier
	IQC33-30 25pcs	Data carrier
	IQC33-50 25pcs	Data carrier
	V1-G-2M-PUR-ABG-V1-W	Connecting cable, M12 to M12, PUR cable 4-pin, shielded
	V1-G-5M-PUR-ABG-V1-W	Connecting cable, M12 to M12, PUR cable 4-pin, shielded
	V1-G-10M-PUR-ABG-V1-W	Connecting cable, M12 to M12, PUR cable 4-pin, shielded

Release date: 2020-04-24 Date of issue: 2020-04-24 Filename: 204623_eng.pdf

Refer to "General Notes Relating to Pepperl+Fuchs Product Information".

Pepperl+Fuchs Group
www.pepperl-fuchs.comUSA: +1 330 486 0001
fa-info@us.pepperl-fuchs.comGermany: +49 621 776 1111
fa-info@de.pepperl-fuchs.comSingapore: +65 6779 9091
fa-info@sg.pepperl-fuchs.com **PEPPERL+FUCHS**

Safety Information

This equipment has been tested and found to comply with the limits for a Class A digital device, pursuant to part 15 of the FCC Rules. These limits are designed to provide reasonable protection against harmful interference when the equipment is operated in a commercial environment. This equipment generates, uses, and can radiate radio frequency energy and, if not installed and used in accordance with the instruction manual, may cause harmful interference to radio communications. Operation of this equipment in a residential area is likely to cause harmful interference in which case the user will be required to correct the interference at his own expense.

Release date: 2020-04-24 Date of issue: 2020-04-24 Filename: 204623_eng.pdf

Refer to "General Notes Relating to Pepperl+Fuchs Product Information".

Pepperl+Fuchs Group
www.pepperl-fuchs.com

USA: +1 330 486 0001
fa-info@us.pepperl-fuchs.com

Germany: +49 621 776 1111
fa-info@de.pepperl-fuchs.com

Singapore: +65 6779 9091
fa-info@sg.pepperl-fuchs.com

 **PEPPERL+FUCHS**